

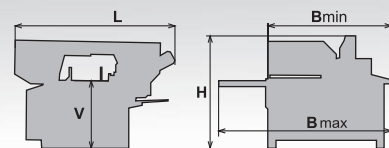













240x280 A-CNC-F



mm	0°		
	260	X	X
	150*	X	X
	290x260	290x160	230x140
	290x260	290x160	230x140

					
3x400V 50 Hz	2,2	20-100	2980x27x0,9		740
L	Bmin	Bmax	Hmin	Hmax	V
1700	1650	2100	1510	2000	910

*doporučené hodnoty /recommended value



PEGAS

240x280 A-CNC-F

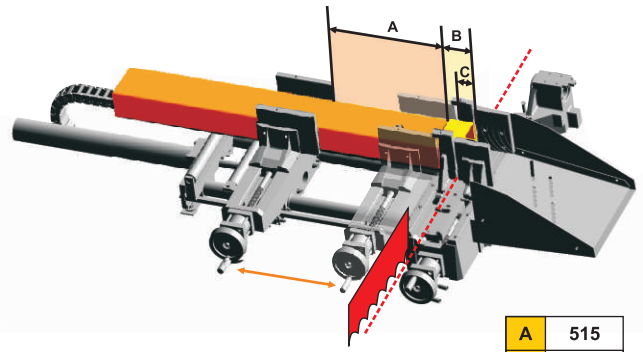

A	515
B	80
C	60

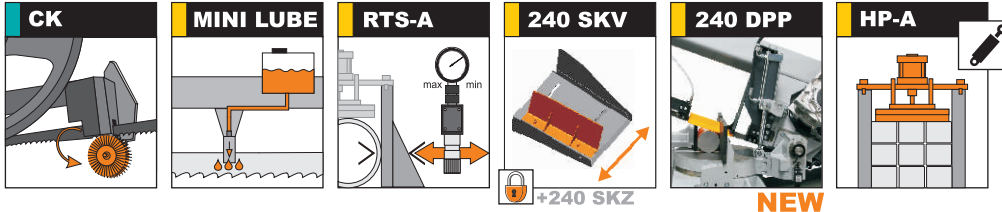

OPTION

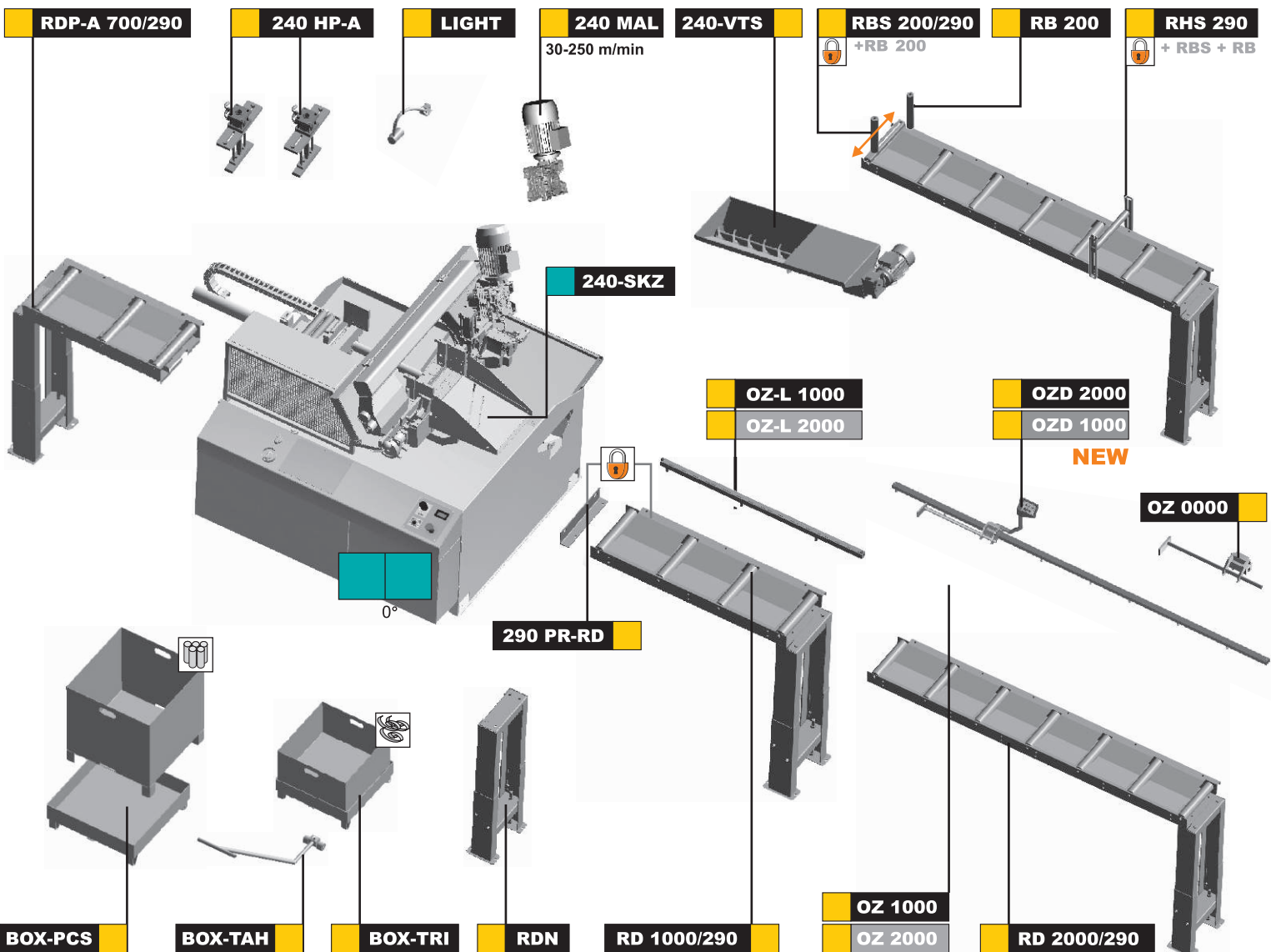

■ STANDARD ■ OPTION



PEGAS-GONDA s.r.o, Čs. armády 322, 684 01 Slavkov u Brna
 Tel: 00420-544 221 125, 00420-544 221 126, fax: 00420 544 227 389
 E-mail: pegas@gonda.cz, www.pegas-gonda.cz, Czech Republic

- výrobce si vyhrazuje právo provádět změny technických údajů, technické údaje odpovídají 1.12.2010
 /producer has the right to make changes of technical data, technical data are valid on 1.12.2010/
 - píla na fotografiích není vždy v základním provedení /the machine in the picture is not always in the basic version
 - uvedené rozměry odpovídají stroji v základním provedení /mentioned diameters are for machine in basic version/