

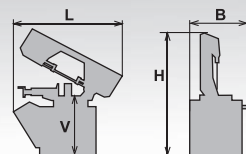

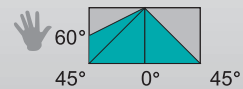











### 350x400 SHI-LR-F



mm	0°	45°	45°	60°	 $\frac{b}{a} \times \frac{b}{a}$	 $\frac{a}{b} \times \frac{a}{b}$
	350	330	320	220	X	X
	250*	180*	180*	130*	X	X
 $\frac{a}{b} \times \frac{a}{b}$	400x350	350x100	330x160	220x240	400x210	230x140
 $\frac{b}{a} \times \frac{b}{a}$	400x350	280x350	240x350	160x350	400x210	230x140

					
3x400V 50 Hz	3,0	20-100	4520x34x1,1		920
L	B	Hmin	Hmax	V	
2300	950	1560	2500	940	

\*doporučené hodnoty /recommended values



# PEGAS

## 350x400 SHI-LR-F

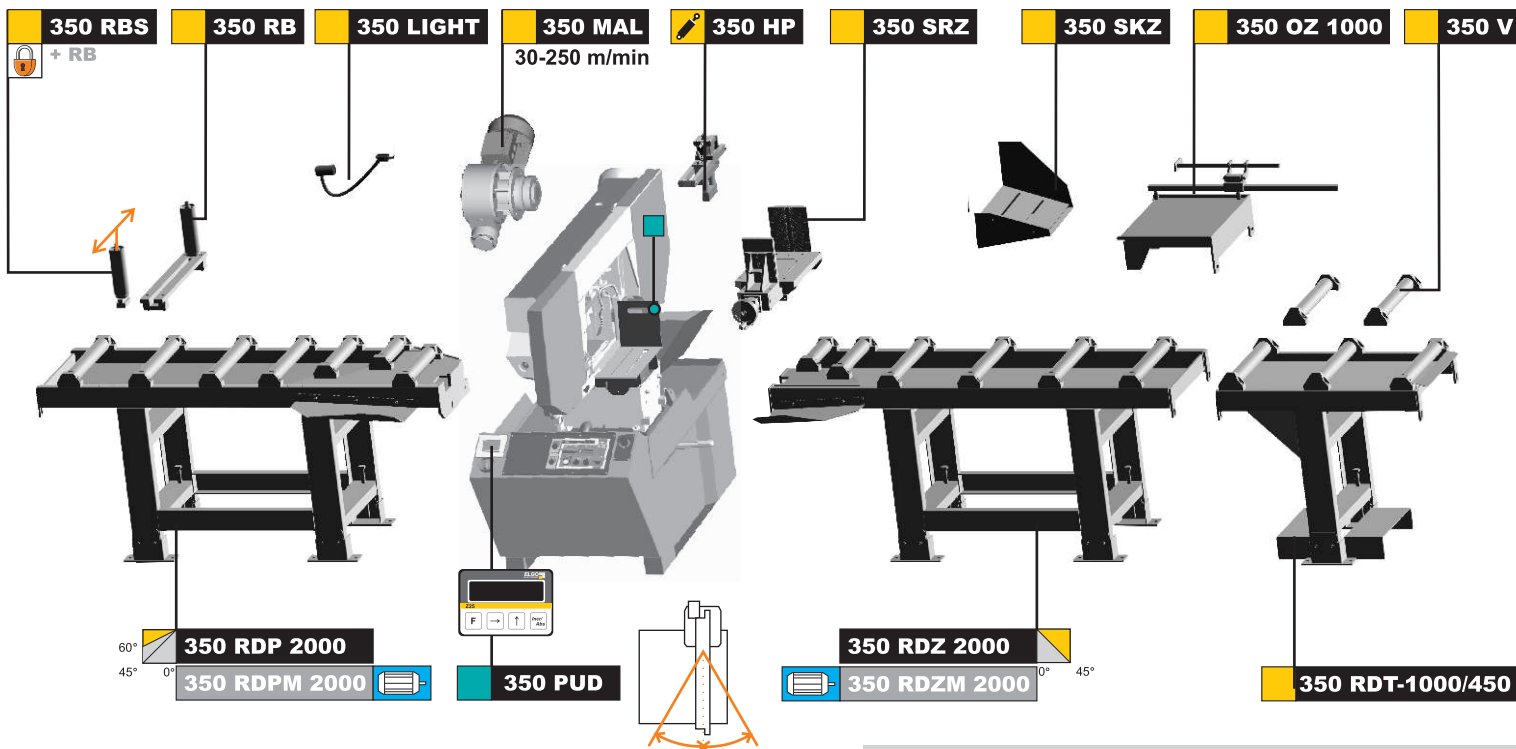
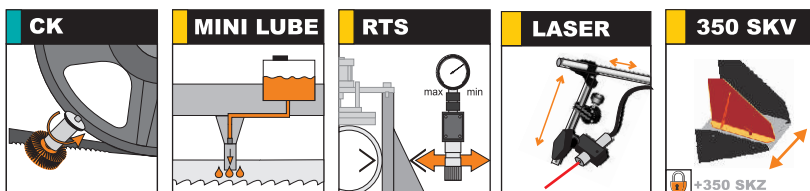

### OPTION

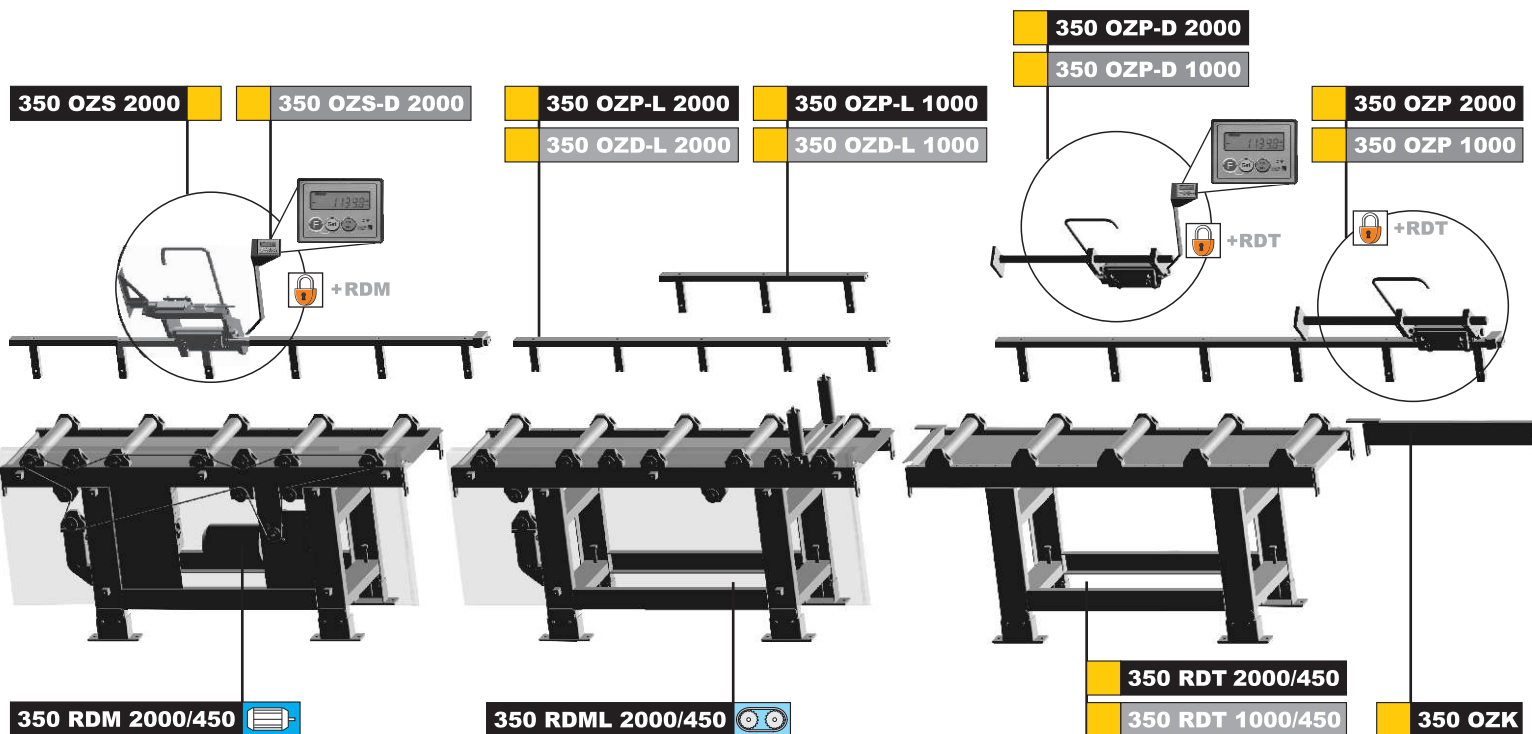

■ STANDARD ■ OPTION



PEGAS-GONDA s.r.o, Čs. armády 322, 684 01 Slavkov u Brna  
 Tel: 00420-544 221 125, 00420-544 221 126, fax: 00420 544 227 389  
 E-mail: pegas@gonda.cz, [www.pegas-gonda.cz](http://www.pegas-gonda.cz), Czech Republic

- výrobce si vyhrazuje právo provádět změny technických údajů, technické údaje odpovídají 1.12.2010  
 /producer has the right to make changes of technical data, technical data are valid on 1.12.2010/  
 - píla na fotografiích není vždy v základním provedení /the machine in the picture is not always in the basic version  
 - uvedené rozměry odpovídají stroji v základním provedení /mentioned diameters are for machine in basic version/