























220x250 GHE-R / 27x0,9

	0°		45°		60°		60°		$\frac{b}{a \times b}$
	220		160		90		x		x
	230x150		160x90		90x90		x		230x120
	3x400V 50 Hz		0,75/1,1		30/65		2450x27x0,9		235
L	1410	B	600	Hmin	1490	Hmax	1750	V	950



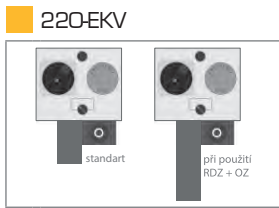

220-EKV



- OZD 1000
- OZD 2000
- OZD 3000
- OZD 4000
- OZD 5000
- OZD 6000

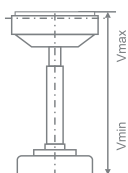
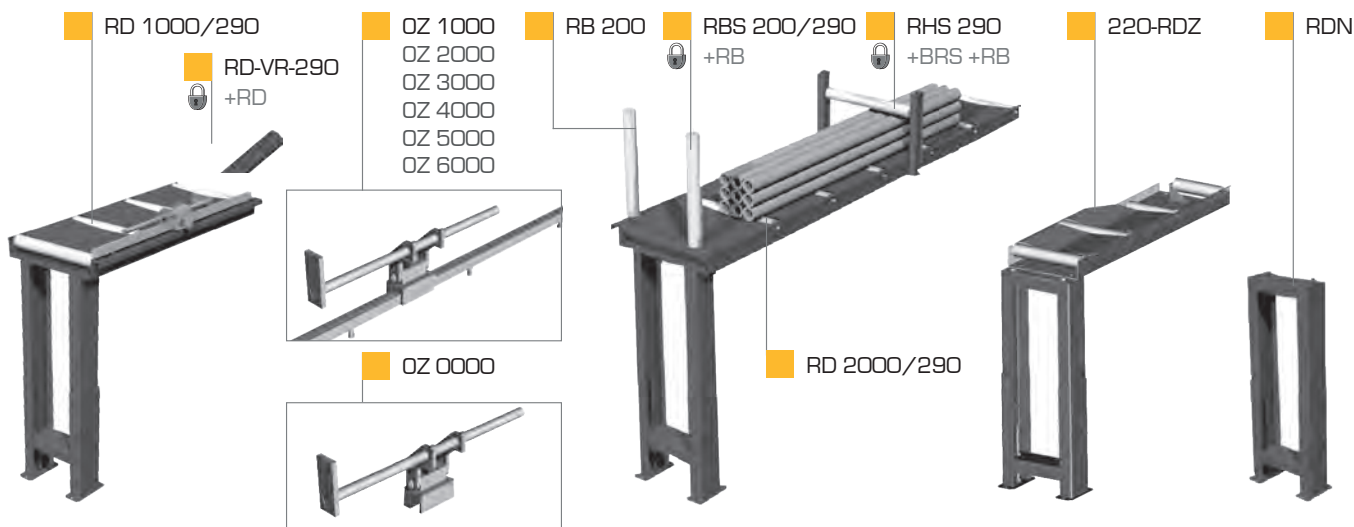

	S (mm)	Vmin (mm)	Vmax (mm)
R290	290	760	980

	S (mm)	L (mm)	Vmin (mm)	Vmax (mm)		
R	290	1000	760	980	4	200
		2000			7	

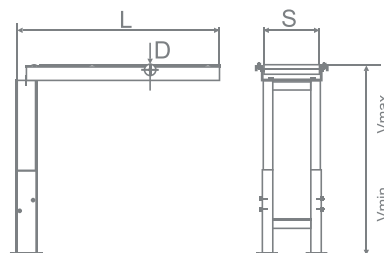

220x250 GHE-R

- výrobce si vyhrazuje právo provádět změny technických údajů, technické údaje odpovídají 1.1.2023 / producer has the right to make changes of technical data, technical data are valid on 1.1.2023

- pila na fotografii není vždy v základním provedení, uvedené rozměry odpovídají stroji v základním provedení / the machine in the picture is not always in the basic version, mentioned diameters are for machine in basic version

* doporučená hodnota. Při překročení doporučeného maximálního průměru není možné garantovat výkon pilového pásu! / recommended value. The blade performance cannot be guaranteed when the recommended diameter is exceeded!

- řezání svazků bez horního přitlačení / cutting of the bundle without top clamping

CONTROL PANEL: GH



PEGAS - GONDA s.r.o.
 Čs.armády 322, 684 01 Slavkov u Brna,
 CZECH REPUBLIC

www.pegas-gonda.cz
 00420-544 221 125 (126) | pegas@gonda.cz